

MOTOROLA SEMICONDUCTOR TECHNICAL DATA

T-33-11
MRF497

2

The RF Line

NPN SILICON RF POWER TRANSISTOR

... designed for 12.5 volt VHF large-signal power amplifier applications in commercial and industrial equipment, operating in the 25 to 50 MHz frequency range.

- Low-Cost, Common-Emitter TO-220AB Package
- Specified 12.5 V, 50 MHz Performance —
Output Power = 40 Watts
Power Gain = 10 dB Min
Efficiency = 60% Min
- Load Mismatch Capability at Rated Voltage and RF Drive

40 W 50 MHz
RF POWER TRANSISTOR
NPN SILICON

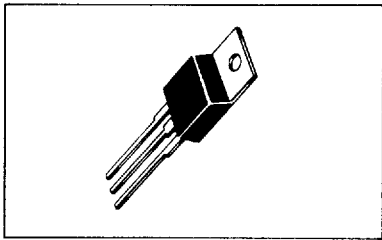

MAXIMUM RATINGS

Rating	Symbol	Value	Unit
Collector-Emitter Voltage	V _{CEO}	18	Vdc
Collector-Base Voltage	V _{CBO}	36	Vdc
Emitter-Base Voltage	V _{EBO}	4.0	Vdc
Collector-Current — Continuous	I _C	6.0	Adc
Total Device Dissipation @ T _C = 25°C (1) Derate above 25°C	P _D	87.5 0.5	Watts mW/°C
Storage Temperature Range	T _{stg}	-65 to +150	°C

THERMAL CHARACTERISTICS

Characteristic	Symbol	Max	Unit
Thermal Resistance, Junction to Case (2)	R _{θJC}	2.0	°C/W

(1) This device is designed for RF operation. The total device dissipation rating applies only when the device is operated as an RF amplifier.
(2) Thermal Resistance is determined under specified RF operating conditions by infrared measurement techniques.

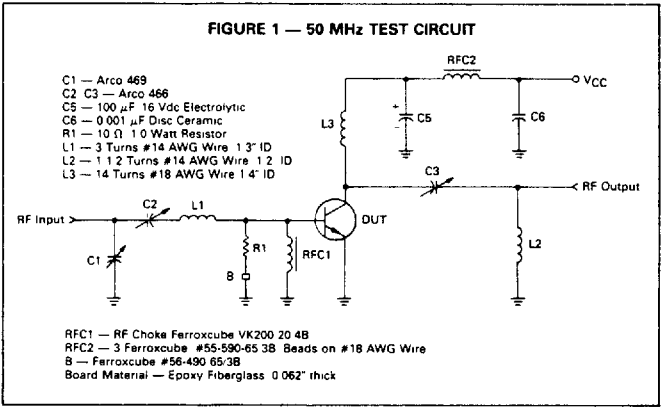
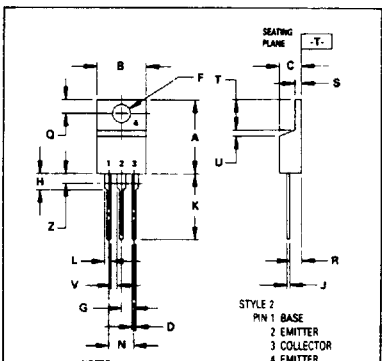

NOTES
1. DIMENSIONING AND TOLERANCING PER ANSI Y14.5M 1982
2. CONTROLLING DIMENSION INCH
3. DIM Z DEFINES A ZONE WHERE ALL BODY AND LEAD IRREGULARITIES ARE ALLOWED

DIM	MILLIMETERS		INCHES	
	MIN	MAX	MIN	MAX
A	14.48	15.75	0.570	0.620
B	9.66	10.28	0.380	0.405
C	4.97	4.82	0.160	0.190
D	0.64	0.88	0.025	0.035
F	3.61	3.75	0.142	0.147
G	2.42	2.46	0.095	0.105
H	2.90	3.93	0.110	0.155
J	0.36	0.55	0.014	0.022
K	12.70	14.27	0.500	0.562
L	1.15	1.39	0.045	0.055
M	4.83	5.33	0.190	0.210
Q	2.54	3.04	0.100	0.120
R	2.04	2.78	0.080	0.110
S	1.15	1.39	0.045	0.055
T	5.97	6.47	0.235	0.255
U	0.00	1.27	0.000	0.050
V	1.15	—	0.045	—
Z	—	2.04	—	0.080

CASE 221A-04 TO-220AB

MRF497

MOTOROLA SC (XSTRS/R F) 46E D 6367254 0094710 2 MOT6

ELECTRICAL CHARACTERISTICS (T_C = 25°C unless otherwise noted)

Characteristic	Symbol	Min	Typ	Max	Unit
OFF CHARACTERISTICS					
Collector-Emitter Breakdown Voltage (I _C = 100 mA, I _B = 0)	V _{(BR)CEO}	18	—	—	V _{dc}
Collector-Emitter Breakdown Voltage (I _C = 20 mA, V _{BE} = 0)	V _{(BR)CES}	36	—	—	V _{dc}
Emitter-Base Breakdown Voltage (I _E = 10 mA, I _C = 0)	V _{(BR)EBO}	4.0	—	—	V _{dc}

T-33-11

ON CHARACTERISTICS

DC Current Gain (I _C = 1.0 A, V _{CE} = 5.0 V _{dc})	h _{FE}	20	—	—	—
---	-----------------	----	---	---	---

DYNAMIC CHARACTERISTICS

Output Capacitance (V _{CB} = 15 V _{dc} , I _E = 0, f = 1.0 MHz)	C _{ob}	—	—	250	pF
--	-----------------	---	---	-----	----

FUNCTIONAL TESTS

Common-Emitter Amplifier Power Gain (V _{CC} = 12.5 V _{dc} , P _{out} = 40 W, f = 50 MHz)	G _{pE}	10	11.2	—	dB
Collector Efficiency (V _{CC} = 12.5 V _{dc} , P _{out} = 40 W, f = 50 MHz)	η	60	—	—	%

2

FIGURE 2 — POWER GAIN versus FREQUENCY

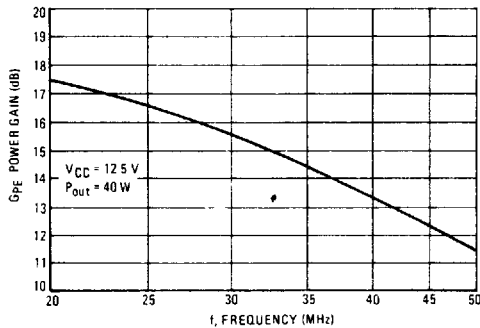

FIGURE 3 — OUTPUT POWER versus INPUT POWER

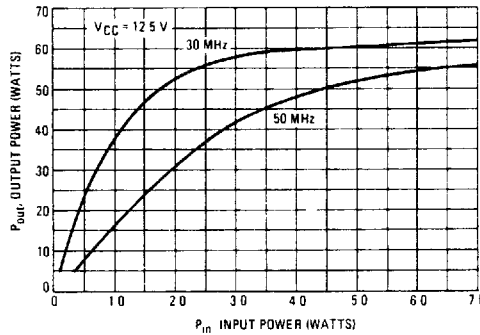
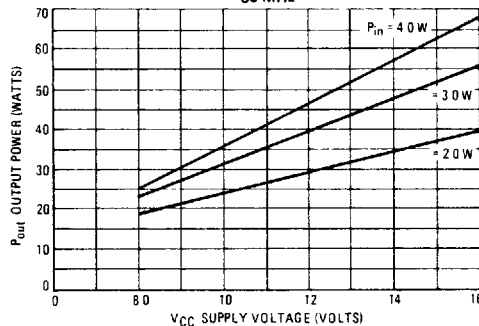

FIGURE 4 — OUTPUT POWER versus SUPPLY VOLTAGE
50 MHz



MRF497

MOTOROLA SC (XSTRS/R F) 46E D ■ 6367254 0094711 4 ■ M0T6

FIGURE 5 — SERIES EQUIVALENT INPUT/OUTPUT IMPEDANCES

T-33-11

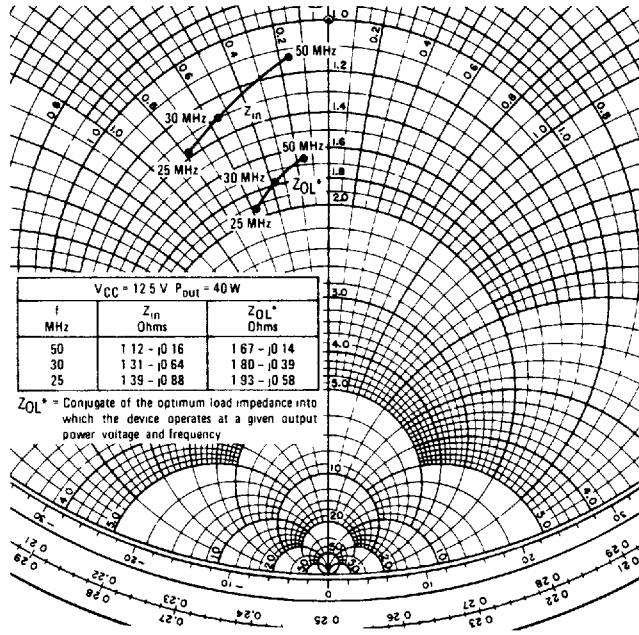

2

FIGURE 6 — TEST AMPLIFIER PCB PHOTOMASTER

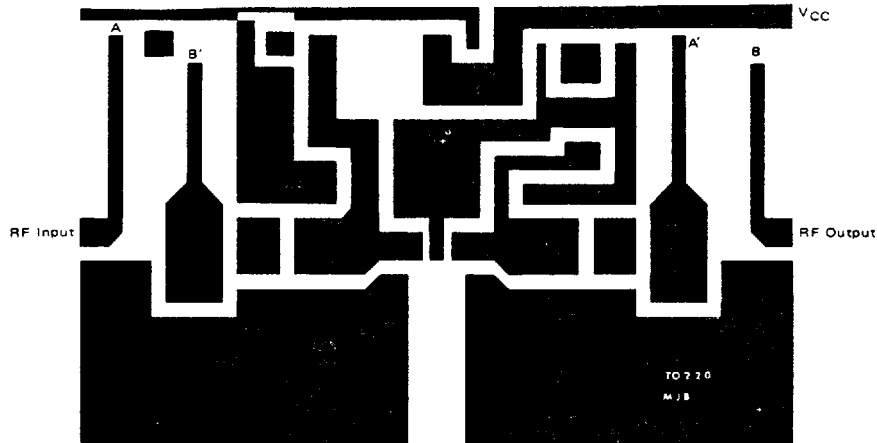

NOTE Points A, A' and B, B' are connected via 50 Ω coaxial cable under the PCB
The Printed Circuit Board shown is 75% of the original.